

THE BROADCAST ENGINEERS' JOURNAL
Ed. Stolzenberger, Editor
116-B 91st Avenue Richmond Hill 18, N. Y.

Postmaster: If undeliverable for any reason,
notify sender, stating reason, on form 3547,
postage for which is guaranteed.

F A GEHRES WGBF-WEQA
2232 E POWELL
EVANSVILLE 14 (IND)
S151

POSTAGE

PAID

New York, N. Y.
Permit No. 2961

OFFICIAL PUBLICATION OF THE NATIONAL ASSOCIATION OF BROADCAST ENGINEERS AND TECHNICIANS



F. A. Gehres
**The
Broadcast
Engineers'
Journal**

VOL. 15

No. 2

FEBRUARY

1948

SINCE 1934 . . . OF, BY AND FOR

THE BROADCAST ENGINEER

U S POSTAGE
Sec. 562, P. L. & R.

A major Advancement in the Recording Blank Field . . .

10 Year Guarantee

**GOULD-MOODY PROFESSIONAL QUALITY "BLACK SEAL"
ALUMINUM INSTANTANEOUS RECORDING BLANKS
AT NO INCREASE IN PRICES!**

After prolonged research and experimentation, we have introduced technological improvements into "Black Seal" blanks that not only increase the life span, but materially enhance the other fine characteristics of these blanks. And so positive are we of the performance of these perfected "Black Seals" that we've placed an unconditional guarantee of ten years on each one of them.

What Does This Guarantee Mean to You?

It means that Gould-Moody "Black Seal" blanks will not rip up, disintegrate or powder after the first playing if kept in storage for any long period of time. It means that atmospheric conditions and changes, moisture and dampness, and old age will have no effect on blanks bearing "Black Seal" labels. It means that you'll be in no danger of losing valuable recordings in what, up until now, you have considered your safe library of recordings. And it means that you can expect the finest reproduction from the finest blank you have ever had on your turntable.

You Can't Afford To Be A Recording Isolationist

Whether you're a recording engineer in New York, Burbank or Wichita . . . no matter how well satisfied you are with your present blanks — you can't afford to be a recording isolationist now. Try these new Gould-Moody "Black Seal" blanks. Cut a few. If, for any reason whatsoever, you do not like them, you can return them at our expense.



**GOULD-MOODY'S PREFERRED RESHARPENING SERVICE
restores the point on your precious recording needle
SAPPHIRE! STELLITE!**

Exact workmanship assures lower surface noise and longer wear. In fact, needles and styls refinished by Gould-Moody are frequently reported to last longer than the original points. And the extreme accuracy with which that last 3/1000ths of an inch is shaped enables the needle to fit with microscopic perfection into the groove, thereby reducing record wear to minimum. This saving, in many cases, exceeds the cost of Gould-Moody resharpening.

THE GOULD-MOODY COMPANY

RECORDING BLANK DIVISION

395 BROADWAY, NEW YORK 13, N. Y.

Broadcast Radio Engineers

who want

this →

specify

this →

because the Shure Super-Cardioid Broadcast Dynamic Microphone has a super-cardioid pickup pattern which reduces the pickup of unwanted random noise energy by 73%. It is twice as unidirectional as the cardioid. In the super-cardioid pattern, the ratio of front-to-rear pickup is 14 to 1—in the cardioid, 7 to 1. There is a wide, useful pickup angle at the front of the microphone while the rear response is down of the order of 15 db over a broad range of frequencies. Reverberation energy pickup is decreased over two-thirds. The microphone can be placed close to the reflecting surfaces without objectionable effects if the rear side of the microphone is toward the reflecting surface.

The Shure "556" Dynamic Microphone has an Acousto-Mechanical circuit containing a single moving-coil element, which operates in conjunction with a high flux magnet and provides high efficiency and smooth peak-free response from 40 to 10,000 cycles. The super-cardioid pattern is achieved in a single unit, due to the "Uniphase" principle—a patented Shure development. The moving-coil unit is provided with a double wind-screen to permit quiet outdoor operation. As a precaution against mechanical vibration pickup, the unit is spring-suspended inside the microphone case, which in turn is floated in live rubber in the special Vibration Absorbing Unit, which eliminates reproduction of vibration transmitted through the stand. The microphone also has a standard 5/8"-27 thread which permits mounting on any Shure desk or floor stand. Adapters to other stands are obtainable when needed. Case dimensions: 4 1/4" high, 3 1/4" wide, 3 1/2" deep. Shipping weight, 4 1/2 lbs.

Patented by Shure Brothers, Inc.

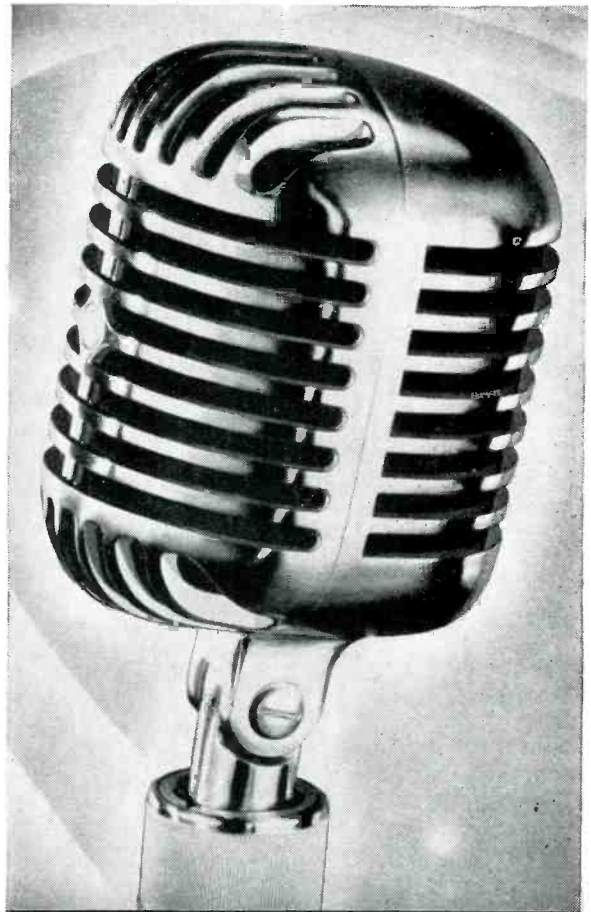
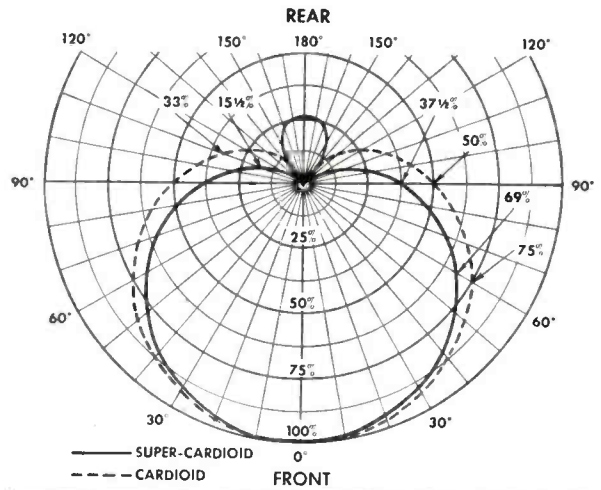

SHURE SUPER-CARDIOID DYNAMIC MICROPHONE

MODEL "556"

Code: RUMUB • List price: \$87.50

MULTI-IMPEDANCE SWITCH ON MODEL "556"

IMPEDANCE TABLE	OUTPUT LEVEL
L—35-50 ohms	56.1 db below 1 Milliwatt per 10 microbar signal
M—150-250 ohms	56.8 db below 1 Milliwatt per 10 microbar signal
H—High Impedance	55 db below 1 volt per microbar

SHURE BROTHERS, Inc.

MICROPHONES AND ACOUSTIC DEVICES

225 W. Huron Street

Chicago 10, Illinois

CABLE ADDRESS: SHUREMICRO

For Truly Fine Recording and Reproduction



Professional Recordists Use—
Professional Recordists Recommend—

audiopoints*

THE NEWLY EXPANDED LINE of Audiopoints now covers the full range of recording and playback needs. There are Audiopoints that fully meet the requirements of the most exacting professional recordists. There are also Audiopoints which these engineers unhesitatingly recommend to the non-professional and the general public.

RECORDING AUDIOPOINTS

Sapphire #14. Long recognized by recording engineers as the best recording stylus obtainable. Manufactured to rigid specifications. Discussed on a recording machine just before packaging. List price **\$7.25.**

Sapphire #202. A fine quality brass shank stylus, ideally suited for those recordists not requiring the super quality of Sapphire Audiopoint #14. List price **\$5.25.**

Stellite #34. Favorite with many professional and non-professional recordists. Though moderately priced, it is the very best stellite stylus produced. List price **\$1.75.**

Diamond-Lapped Steel #50. Most practical stylus for home recordists when "first cost" is important. Being diamond-lapped, it cuts a quiet, shiny groove. List price **3 for \$1.00.**

PLAYBACK AUDIOPOINTS

Sapphire #113. Materials, workmanship and design make this playback point the finest made for original recordings and vinyl transcriptions. For years the outstanding choice of professional recordists. List price **\$6.50.**

"Red Circle" Sapphire #103. With straight dural shank and fine polished jewel point. Excellent for original recordings, vinyl pressings and phonograph records. List price **\$2.00.**

"Red Circle" Sapphire #303. Bent dural shank sapphire needle that is tops for phonograph records. *For the first time a phonograph needle with a resharpening feature.* List price **\$2.00.**

Steel Transcription Needle #151. The ideal all-purpose transcription needle for original recordings, vinyl pressings and phonograph records. Quality performance is assured since each point undergoes a shadow-graph test. List Price **20 for 25c**

Write for new dealer discounts and our folder "Audiopoints."

*Reg. U. S. Pat. Off.

RESHARPENING SERVICE

Established years ago, our resharpening service gives real economy in the use of Audiopoints #14, #202, #34, #113, #103 and #303.

Audiopoints are a product of the manufacturers of Audiodiscs.

AUDIO DEVICES, INC., 444 Madison Ave., New York 22, N. Y.

THE BROADCAST ENGINEERS' JOURNAL

Ed. Stolzenberger

Editor and
Business Mgr.

Editorial, Advertising and Circulation Offices:
116-03 91st Avenue, Richmond Hill 18, N. Y.
Telephone: Virginia 9-5553

Volume 15, No. 2

February, 1948

Contents copyright, 1948, by NABET Publications

TABLE OF CONTENTS

	Page
NABET News	4
Field Conversion of 1126-Type Level-Governing Amplifiers	5
Review of Current Technical Literature	12
Du Mont Television Camera	14
Washington News	16
Chicago News	19
Labor History—Part IV	20

THE BROADCAST ENGINEERS' JOURNAL

OFFICIAL PUBLICATION OF THE N. A. B. E. T.

Trustees: D. J. MOLONEY, *Chairman*; E. CLARK, A. G. POPPELE,
J. R. McDONNELL, W. L. STAFFS, C. WESTOVER

Secretary-Treasurer H. E. HILLER

ASSOCIATE EDITORS

Baltimore	ROYCE HEINTZ
Boston	JAMES W. HUGHES
Chicago	MINOR J. WILSON
Cleveland	EARL HOLL
Denver	CHAS. M. EISING
Detroit	DAVE STEWART
Dixie	D. GORDON McCRARY
Engineering Chapter	E. B. BERLUND, JACK IRVING
Hollywood	NORMAN DEWES
Hudson Chapter	AL KING
Mohawk	J. W. GAGNE
New York	DUD CONNOLLY, PAT SIMPSON
Omaha	CY HAGRMAN
Philadelphia	
Pittsburgh	FRANK E. HENRY
Rochester, N. Y.	GEORGE WILSON, DONALD ANDERSON
San Francisco	KEN MARTIN, JACK VAN WART
St. Lawrence, N. Y.	MISS ALEEN CORBIN
Washington	WARREN D. DEEM

The Broadcast Engineers' Journal is a privately printed monthly publication issued by NABET Publications. Address all communications to Publication office: E. Stolzenberger, 116-03 91st Avenue, Richmond Hill 18, L. I., N. Y. Telephone Virginia 9-5553.

Advertising rates and information supplied on request. Subscription, \$2.50 per year; \$4.00 for two years. Single copies, except Christmas Yearbook, 35c; Christmas Yearbook, \$1.00. All remittances in advance. Foreign: add postage. Back copies 50c, back Yearbooks, \$2.00.

Nothing appearing in The Broadcast Engineers' Journal shall be construed to be an expression of The Broadcast Engineers' Journal or the National Association of Broadcast Engineers and Technicians, but must be construed as an individual expression of the author or authors.

NATIONAL N.A.B.E.T. OFFICE

Room 501, 66 Court Street, Brooklyn 2, N. Y.

J. R. McDonnell, Vice-President

MAin 4-2855



25th

ANNIVERSARY!

The world's finest
precision disc
recording machine —
used and recommended
wherever the finest
recordings are made

«»

Today — Write, Phone, or Wire
your order for

SCULLY MASTER RECORDERS

«»

SCULLY
Machine
Company

62 Walter Street

Bridgeport 8, Conn.

Telephone BRidgeport 4-5300

Attention Broadcast Engineers!

National Association of Broadcast Engineers and Technicians

The only Union
that is 100%
Of, By and For the
BROADCAST
ENGINEER

- NABET is a dignified union *worthy* of your support.
- NABET is an *effective* union, Of, By, and For the Broadcast Engineer *exclusively*, operated upon and dedicated to the principle that every member has a *right* to know what is going on in the union's "front office."
- NABET is controlled by its *members*: they have the right to vote on all matters of union policy. As a NABET member, you would have the *right* to Okay any action which your President might take.

Contact any of the following officers for further information:

J. R. McDonnell, Vice-Pres.
H. E. Hiller, Sec'y-Treas.
C. L. Gorsuch, Nat'l Rep.
66 Court St., Room 501
Brooklyn 2, N. Y.
MAIn 4-2855

Chapter Chairmen

Baltimore:
John W. Lappe
804 Register Avenue
Baltimore 12, Md.

Boston:
Elmer M. Lantz
Concord Road
S. Lincoln, Mass.

Chicago:
Arthur Hjorth
404 W. Evergreen, Apt. 51
Chicago 10, Ill.

Cleveland:
Harold V. Brandt
19 Elm St.
Brecksville, Ohio

Detroit:
Roger K. Ellis
820 University Pl.
Detroit 30, Mich.

Dixie:
J. Willard Dean
217 E. North St.
Raleigh, N. C.

Engineering:
Wm. L. States
92-05 Whitney Ave.
Elmhurst, N. Y.

Hollywood:
James H. Brown
6000 Sunset Blvd., Room 105
Hollywood 28, Calif.

Hudson:
Eugene Clark
17 Poplar St.
Ridgefield Park, N. J.

Mohawk:
Donald P. Morey
3 Circle Lane, Apt. 26-A
Albany 3, N. Y.

New York:
Clarence Westover
1 Charles St.
Oceanside, N. Y.

Omaha:
D. Roy Glanton
5500 Kansas Ave., Rt. 2
Omaha 12, Neb.

Philadelphia:
Walter S. Gilbert
Smith and Oak Streets
N. Wales, Pa.

Pittsburgh:
O. C. Beitel
118 Prospect St.
Avalon, Pgh. 2, Pa.

Rochester:
Edward Lynch
109 Wolcott Ave.
Rochester 11, N. Y.

Rocky Mountain:
George Pogue
1415 Hudson St.
Denver 7, Colo.

San Francisco:
John R. McDonnell, Vice-Pres.
252 Oakdale Ave.
Mill Valley, Calif.

St. Lawrence:
George Gebhard
134 William St.
Watertown, N. Y.

Syracuse:
Donald Muir
1200 W. Colvin St.
Syracuse 7, N. Y.

Washington:
John H. Hogan
9312 Sudbury Rd.
Silver Spring, Md.

Section Chairmen

Atlanta:
Broughton W. Benning
2715 Stewart Ave.
Atlanta, Ga.

Fairmont:
Thomas Moore
209 1-2 Watson Ave.
Fairmont, W. Va.

Louisville:
Kermit B. Smith
1211 S. 6th St.
Louisville, Ky.

Richmond:
Lewis V. Parrish
1615 Grove Ave.
Richmond, Va.

Springfield:
George R. Townsend
Southampton Road
Westfield, Mass.



A Message to the Members of NABET

from

JOHN R. McDONNELL
Vice-President, NABET

A survey of NABET's assets at the start of a new year should convince anyone that our principal asset is an enlightened membership. This membership, secure in a democratic organization, look forward to the increased potency of NABET in the field of Labor Management relations as 1948 progresses. I feel confident that this faith will be justified as we continue to raise the standards and improve the status of the Radio Engineer.

JOHN R. McDONNELL

NABET Vice President John R. McDonnell was born Dec. 7, 1911, in Spokane, Washington, of Scotch and Norwegian parents. In 1926, he was first exposed to radio broadcasting as a member of the Radio Club at the North Central High School in Spokane, which owned and operated radio station KFIO. Operations consisted of going on the air a few hours a week with broadcasts of the athletic events, the school band and orchestra and such other free material as was available.

Mac obtained his first radio license (broadcast class) in 1929. When the school found it could no longer support its radio station, it was sold to commercial interests, and McDonnell went to work for the station as its first employee.

He alternated between more school and more KFIO until the fall of 1933 when he moved to California and worked at various radio jobs—technician, announcer, salesman, etc., until the spring of 1941 when Mac went with the NBC Engineering Dept in San Francisco; he subsequently transferred to the ABC Engineering Dept, where he remained until the fall of 1947 when he took a leave of absence after finding that he had been projected from the Chairmanship of the San Francisco Chapter into the job of actively heading the NABET National Office in New York.

On August 30, 1940, McDonnell induced Lois Pearce of Spokane to say "I do." The McDonnells settled in Mill Valley, California (where it *never* snows)—a small residential village about thirteen miles north of San Francisco in Marin County. Mac says, "Quail run around our back door. Ah! California!" Mr. and Mrs. McDonnell have two daughters, Candace (Candy) aged 5, and Nickie, age three. The two Misses saw their first snow this winter in New York, and what happened December 26th quite amazed them—and Daddy too! Mac stands 6 feet, 5½ inches, and weighs 180 pounds.

If it concerns the Broadcast Engineer—
he will read about it in the
Broadcast Engineers' Journal

Field Conversion of 1126-Type Level-Governing Amplifiers

By K. P. DOWELL
Western Electric Company

Since the original design of the Western Electric 1126 type program-operated level-governing amplifier, nicknamed the POLGA, Bell Telephone Laboratories have made improvements in the 1126 circuit. These improvements are incorporated in the latest model, the 1126C. The changes required in the 1126A and 1126B amplifiers to convert them to 1126C are described below and may readily be made in the field by present users.

The 1126 type amplifiers prevent overmodulation of the radio transmitter or overload of recording equipment, line circuit equipment, or other transmission media through rapid and automatic gain reduction when a peak of audio signal occurs that is capable of causing overload. The automatic control circuit restores full gain as rapidly as disappearance of excessive peaks will allow. These amplifiers are essentially peak actuated attenuators with a self-restoring feature, the most desirable type of level-governing amplifier

because it operates in a manner identical to that of a very high speed and highly accurate attenuator, reducing the amplitudes of signal peaks without distorting the waveforms. Other types, such as peak clippers, distort the waveforms in the process of reducing the amplitudes.

With a level-governing amplifier, an AM broadcast station may operate with a higher average percentage of modulation, thus obtaining more effective coverage of the station's service area (equal to that which would be obtained by more than doubling the transmitter power) without experiencing the audio distortion or creating the interference in adjacent transmitter channels that may result from recurring overmodulation peaks. An FM station using a level-governing amplifier can avoid distortion in the listener's receiver (through frequency overswing into the non-linear portion of the receiver discriminator characteristic) caused by frequency swings greater than ± 75 kc. (100

per cent modulation). In recording systems the level-governing amplifier allows maintenance of a high recording level and better signal-to-noise ratio without danger of overcutting (into adjacent grooves) or damage to sensitive recording heads. For these reasons, level-governing amplifiers are widely used in AM and FM broadcasting, recording systems, and other audio frequency systems where limiting action is desired.

The use of a limiting amplifier to secure these beneficial effects for program transmission originated with Bell Telephone Laboratories and Western Electric, and the first such commercial amplifier, the 110A, was produced over ten years ago. Many of these units are still in regular service.

There are five major requirements that a high quality level-governing amplifier should meet:

1. High compression ratio and stability of this ratio above the point where

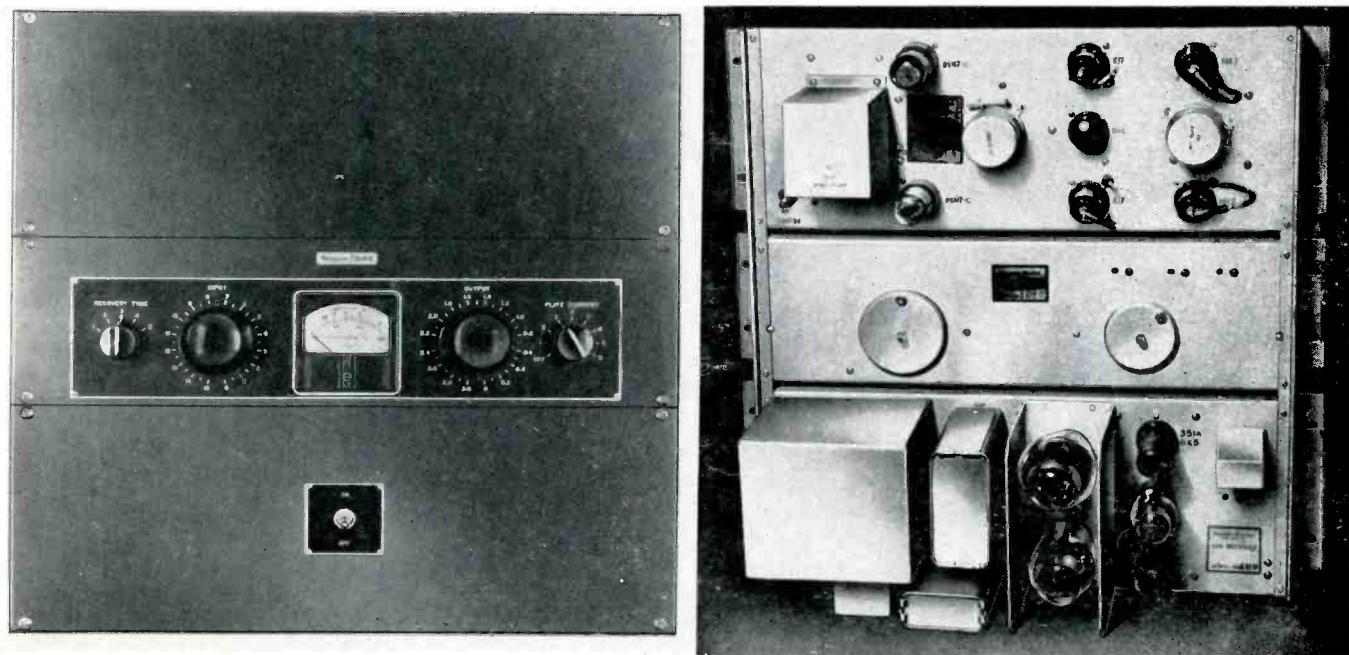

Figure 1 (Left)—Front view of the Western Electric 1126C Program-operated level-governing amplifier used in both AM and FM broadcasting systems to avoid undesirable effects which would result from overmodulation of the radio transmitter. The three units, 126C amplifier (top), 298A control panel (center) and 20B rectifier (bottom), may be installed separately to satisfy various operating requirements. Figure 2 (Right)—Rear View of the Western Electric 1126C Amplifier. At the top is the 126C amplifier, in the center is the 298A control panel, and at the bottom is the 20B rectifier.

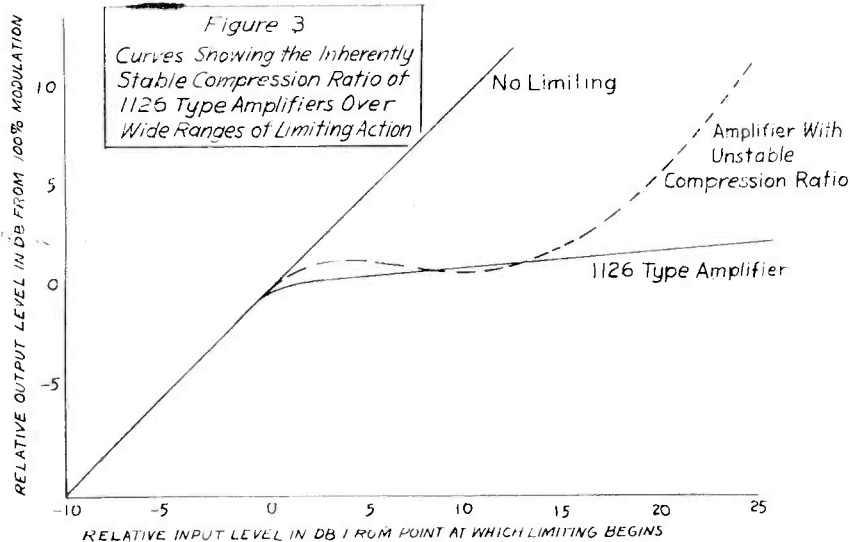

Figure 4B
Limiter Disabling Switch Circuit in Early Models of 1126B Amplifier

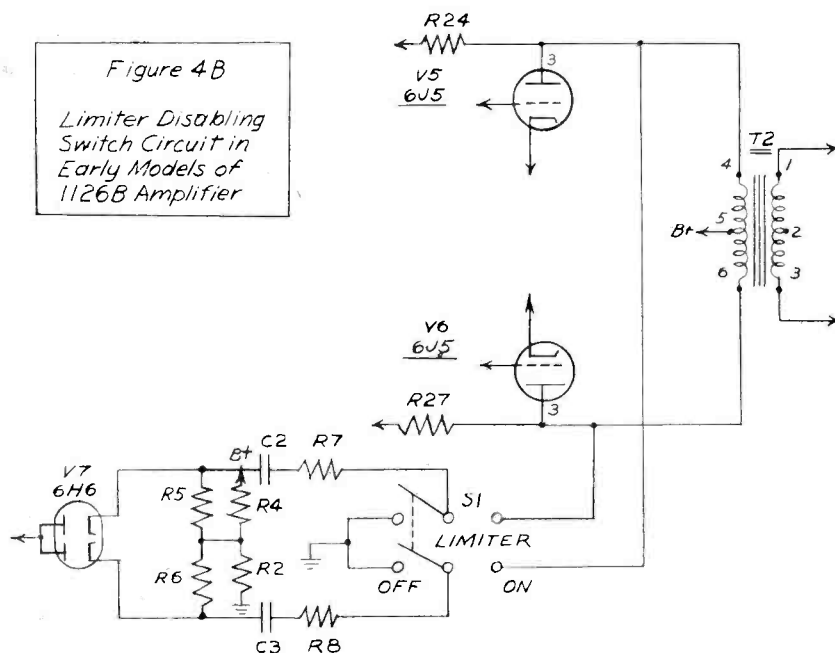
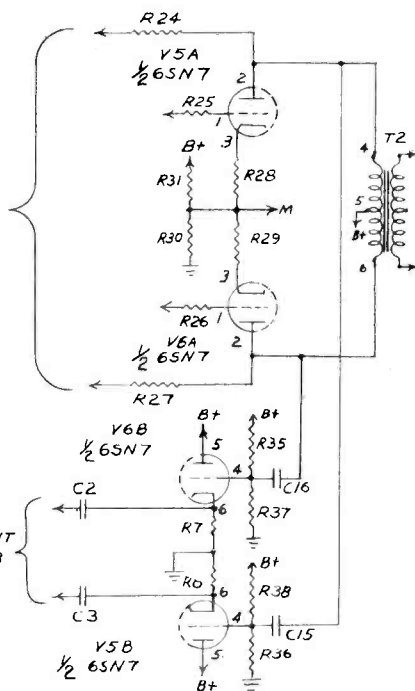

FIGURE 5
126C AMPLIFIER
SIMPLIFIED SCHEMATIC

INPUT STAGES
IDENTICAL WITH
126B AMPLIFIER

CONTROL CIRCUIT
SAME AS IN 126B
AMPLIFIER



gain reduction starts. Compression ratio is the ratio of a given increase (in db) of input level above the point at which limiting begins to the resulting db increase in output level.

2. Stability of the level at which gain reduction starts.
3. An attack time (time required for gain reduction to occur) sufficiently short that no audible distortion occurs from normal operation.
4. A release, or recovery, time (time required for gain to be restored to normal) longer than the syllabic frequency of speech but no longer than necessary to avoid audible effects with program material. This release time may vary over wide limits, providing it is sufficiently fast—0.1 to 0.5 seconds. If the release time is too long, gain reduction is in effect most of the time, and the primary purpose of the device to limit peaks is defeated, for, since the transmitter would be modulated at a lower percentage, the same result could be obtained from a lower gain setting. In addition, a recovery time that is too long causes an interval of low audio gain on a change from a high to a low level program, precluding rapid changes of program level. A further deficiency is that high level peaks of considerable magnitude will cause the gain to drop severely, and with the slow recovery time a "hole" is bound to occur in the program.
5. Fidelity comparable to other components in the system.

The 1126 type amplifiers meet these requirements. They have a very high compression ratio, and, because of the self-balancing or degenerative action of the 1126 circuit, the shape of the input versus output curve over wide ranges of limiting action is inherently held to close and stable limits. Figure 3 shows the constant slope (indicating stable compression ratio) of the curve for the 1126 type amplifiers over wide ranges of compression. In some types of limiters the stability of the point at which limiting begins is not readily maintained, and the shape of the input versus output curve over wide ranges of limiting action is neither stable nor satisfactory, as indicated in Figure 3.

A safety feature, the inclusion of a peak chopper that prevents the output level from rising at any time more than approximately 2½ db above the level at which limiting begins, is another advantage.

age of the 1126 type amplifiers. This feature functions independently of the control circuit; therefore, complete disabling of the control circuit will not allow serious overmodulation. In some types of limiters having an unstable input versus output curve, a sharp upward bending of the curve at values in excess of about 15 db of limiting action permits levels to pass through at far above the overmodulation level (note Figure 3). The safety circuit in the 1126, particularly designed to catch the rare almost instantaneous peaks on program lines occurring from lightning surges in the vicinity of the transmitter, provides a protection not found in ordinary limiting amplifiers against damage from such abnormal overloads which exceed the operating range of the control circuit or from any other occurrence which might render the control circuit inoperative. Protection is therefore complete.

The attack time requirements are met in the 1126C by an automatic control circuit that acts so rapidly that within 0.1 millisecond an input signal approximately 20 db above that required for 100 per cent modulation can be reduced so that normal maximum output is not exceeded. This time was not arrived at by chance, but resulted from a large background of experience with control devices in the telephone and recording fields. A shorter attack time than 0.1 millisecond can be obtained; however, a shorter time is not necessary, because natural limitations prevent any amplitude changes, particularly in an amplitude modulated transmitter, which can occur in a time of less than 0.1 millisecond. These limitations result from the restricted frequency range and phase distortion of microphones, amplifiers, lines, and the many other elements entering into the audio frequency chain. It is impossible, without knowing the exact circuit constants, to state the minimum time required for any peak to build up; it can be stated conservatively, however, that for the average overall audio system the minimum average time required for any sudden peak to build up to its maximum value will generally be in excess of 0.1 millisecond and rarely less than 0.3 millisecond. These values are for an audio frequency transmission band which is nominally from 50 to 15,000 cycles. Under normal operating conditions for AM, of course, where the frequency band is restricted to 8 or even 5 kilocycles, the minimum time required for a peak to build up is considerably in excess of the values quoted. It can, therefore, be appreciated that the speed capabilities of the 1126C, in which the control

circuit functions in 0.1 millisecond, cannot be exceeded under normal operating conditions, and that for all practical purposes the effectiveness of the 0.1 millisecond attack time is as great as that for limiters for which zero attack time is claimed.

Optimum release time for a level-governing amplifier depends upon the type of program material being transmitted. Approximately 0.5 or 0.6 seconds is a reasonable compromise to insure effective increase in signal strength while at the same time not distorting high quality program material. On pickups from studios having a long reverberation time, 0.8 or 1.0 second recovery time may give better results. On the other hand, recovery time as short as 0.1 or 0.2 seconds may be required for some other types of program material. The 1126C provides a front panel adjustment of recovery time (R, Figure 4A) that covers the range from 0.2 to 1.0 seconds in 0.2 second steps; or, by the simple removal of C14 (see Figure 4A), the range 0.1 to 0.5 seconds in 0.1 second steps is obtained.

The fidelity of the 1126 type amplifiers makes them suitable for the highest quality program material. Frequency response is uniform within 1 db of the 1000-cycle value over the range 30 to 15,000 cycles. The 1126 has extremely low steady-state distortion and noise level. Distortion is only approximately one half of one per cent or less for output levels below limiting. Distortion with limiting action occurs only during the short intervals of time that limiting is in effect and is less than one per cent for frequencies above 200 cycles and not more than two per cent for frequencies as low as 50 cycles for 5 db compression; during limiting of 15 db, distortion is less than two per cent for frequencies above 200 cycles and not more than five per cent for frequencies as low as 50 cycles. The 1126 has a high signal-to-"thump" ratio and is not susceptible to motorboating or instability. By "thumps" are meant shock disturbances at low frequencies (20 cycles or less) which can be caused by clicks or shorts on the line, mishandling of microphones or reproducer heads, or anything that causes the limiter to go in and out of deep compression suddenly. While of less importance in broadcasting, where 20-cycle disturbances are not always transmitted, this phenomenon was especially disturbing in recording circuits.

Performance measurements show that the 1126C fully meets all of the major requirements for an automatic level-governing amplifier suitable for use in the

highest quality program transmission systems: very high and very stable compression ratio, stable level at which limiting begins, extremely short attack time, recovery time variable over the desired range, and fidelity comparable to that of the highest quality audio equipment.

The 1126A was the first of this series of program-operated level-governing amplifiers. It consists of a 126A amplifier, a 20A rectifier, and a 298A control panel. These three units may be mounted together in a standard 19-inch relay rack as shown in Figure 1 or mounted separately to satisfy various operating requirements. The 1126B followed, incorporating some circuit changes found to be desirable after the 1126A had been used in the field for some time. The 1126B includes a 126B amplifier, a 20B rectifier, and a 298A control panel. The changes made in the 126A amplifier circuit include the addition of potentiometer P2 (see Figure 4A) to permit compensation for tube variations by adjustment for dynamic balance of vacuum tubes V1 and V2. Unbalance at this point is likely to cause "thumps." A switch (S1) was added to disable the limiting action during adjustment of P2, and a change was made in C1. C1 was a 0.1 mfd. condenser in the 126A amplifier; in the 126B it was made 0.05 mfd. and another condenser, C14, also 0.05 mfd., added in parallel with C1. This increased the range of release time adjustments, giving the user a greater choice. Since attack time depends upon the rate at which the combination of C1 and C14 is charged, the removal of C14 also shortens attack time slightly. The 20B rectifier, which supplies regulated positive d.c. plate voltage and a.c. filament power to the amplifier, differs from the 20A rectifier chiefly in the use of a power transformer designed to operate from a 50 to 60 cycle source, while the power transformer of the 20A rectifier was designed for only 60-cycle operation. No change was made in the 298A control panel, which contains a meter with its associated switching circuit for measurement of plate or cathode current of each amplifier tube, d.c. voltage from the rectifier, and for compression indication. The control panel also contains the adjustable resistance R (recovery time adjustment) and two precision attenuators, controlled by knobs on the front of the panel and variable in 0.5 db steps for the input circuit and 0.1 db steps for the output circuit.

Figure 4A is a simplified schematic diagram of the 126B amplifier circuit. The 126B consists of three push-pull am-

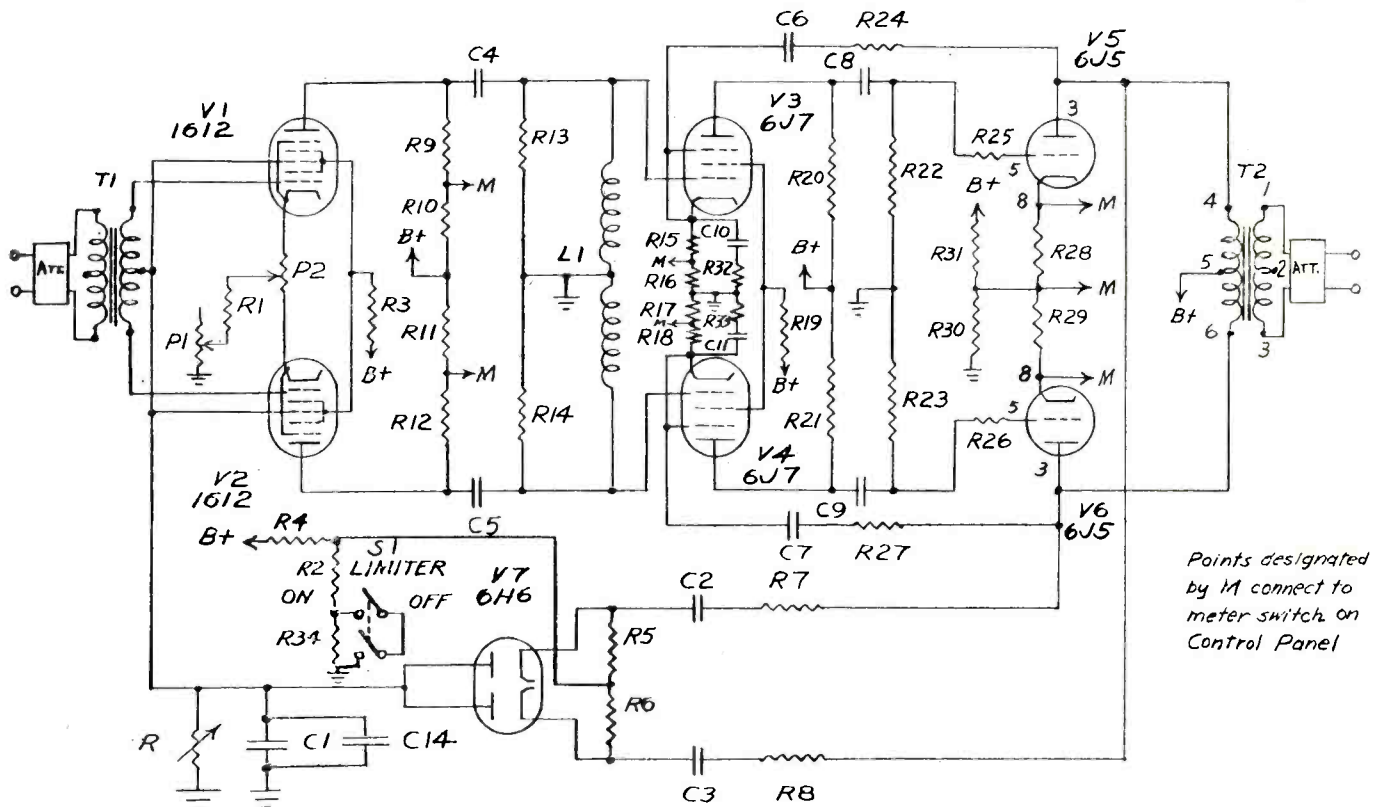

Fig. 4A—126B Amplifier Simplified Schematic

plifier stages and a control circuit for automatic gain reduction on signal peaks. When an overload signal peak sufficient to overcome the positive bias at the cathodes of V7 occurs, the diode conducts, allowing C1 to charge to a negative voltage. This negative voltage, applied to the No. 3 grids of V1 and V2, reduces the gain of this input stage and therefore reduces the output level of the amplifier. This gain reduction occurs almost instantaneously. When the peak is over, the gain restores to normal relatively slowly, for the diode is now in a non-conducting state, and C1 discharges through the resistance R, which is high compared to the impedance of the charging path. The time required for restoration of gain is made adjustable in steps as previously explained.

The time required to charge C1 is the attack time, or operating time, of the level-governing amplifier. It depends upon the time constant of the circuit, which is determined by the capacity of C1 and the impedance of the source from which C1 receives its negative charge. In the 126B this source impedance is dependent upon the impedance of the plate circuits of V5 and V6, the resistance of the isolating resistors R7 and R8, and the impedance of the diode V7 during con-

duction. Reducing this source impedance produces a decrease in the attack time. This was accomplished in the 126C circuit (see Figure 5) by supplying signal to the control circuit from cathode followers. Dual triodes were substituted for the single-triode output tubes, and the first triode sections of each were connected to perform the same function as the original single triodes. The second triode sections were connected as cathode followers to couple the output signal to the control circuit, isolating the control circuit from the amplifier output stage and providing a low impedance source for charging C1. This also made it possible to eliminate R7 and R8 as series isolating resistors (10,000 ohms each), leaving the charging rate of C1 limited only by the low cathode follower output impedance and the impedance of V7 during conduction. The resulting reduction in the attack time allows use of more actual limiting action on program material with minimum degradation of quality. The gain-reducing action is now so rapid that distortion of transient peaks is impossible to detect under the most critical listening conditions.

Thus there are a number of advantages to be gained by converting a 126A or

126B amplifier to 126C. Converting a 126A to 126C involves replacing C1 (0.1 mfd.) with two 0.05 mfd. condensers, the addition of P2 and a disabling switch circuit, the replacement of the output triodes with dual triodes, and the accompanying wiring changes and component additions. The conversion from 126B to 126C requires the same changes except the change in C1 and the addition of P2 and the disabling switch circuit. Early 126B models will also be improved by making changes in the disabling switch circuit that were incorporated in later models (see Figure 4B for the circuit used in early models of the 126B. A "click" could be heard in the amplifier output of the early models when S1 was operated.)

In following the conversion procedures described below and illustrated in the accompanying drawings, it should be kept in mind that there may be some minor differences in the various models in wiring colors, points of connection where several different points of connection are possible (for example, connections to ground, to B+, etc.), and each unit should be checked carefully to determine that the actual wiring arrangement after the modification agrees with the schematic of the 126C, Figures 4A and 5.

Procedure For Conversion of a 126A Amplifier to 126B

Note Figures 4A and 6.

Components required:

- (1) Potentiometer (P2), 0-50 ohms \pm 10 per cent, standard taper; such as I.R.C. type W wire-wound potentiometer. This potentiometer should have a steel shaft 9/16 inches long, preferably with a screw-driver slot.
- (1) Resistor (R34), 56,000 ohms \pm 10 per cent, 1/2 watt, such as Allen-Bradley type EB or I.R.C. type BTS.
- (1) Toggle switch (S1), double-pole single-throw (optional as explained below).
- (2) Condensers (C1, C14), each 0.05 mfd. \pm 20 per cent, 400 V., such as Solar type XTIMSW4.

The addition of P2 and S1 requires simple wiring changes. The wire connecting the cathodes of V1 and V2 should be cut and potentiometer P2 inserted. R1 should be disconnected from the cathode of V1 and connected to the arm of P2. The addition of S1 requires adding R34, inserted between R2 and ground. A simple means of doing this is by mounting R34 on the terminal strip (between R2 and a ground point on the strip) and using a strap connection across R34 to serve as a switch. Or, to eliminate the necessity for unsoldering the strap connection when adjustments are desired, an actual switch (S1) may be inserted as shown in Figure 6. Figure 6 also indicates a convenient place for mounting the switch. C1 (0.1 mfd.) should be replaced by a 0.05 mfd. condenser and C14 added in parallel.

Adjustment of P2 is simple and may be accomplished by applying a 10,000 cycle tone to the input terminals 13 and 14 of the 298A control panel at a level sufficient to give limiting action of at least 5 db and rapidly swinging the input level back and forth over a range of 20 db, readjusting attenuator P2 until the "thumps" are minimized. Selection of a pair of 1612 type tubes having identical characteristics will simplify this procedure.

Procedure For Conversion of a 126B Amplifier to 126C

Note Figures 4A, 4B, 5, 6, 7, and 8.

Components required:

- (2) Vacuum tubes (V5, V6), type 6SN7/GT.
- (2) Condensers (C15, C16), 0.01 mfd. \pm 20 per cent, 400 v.; such as Western Electric type 404C or Cornell-Dubilier type 1DM451.

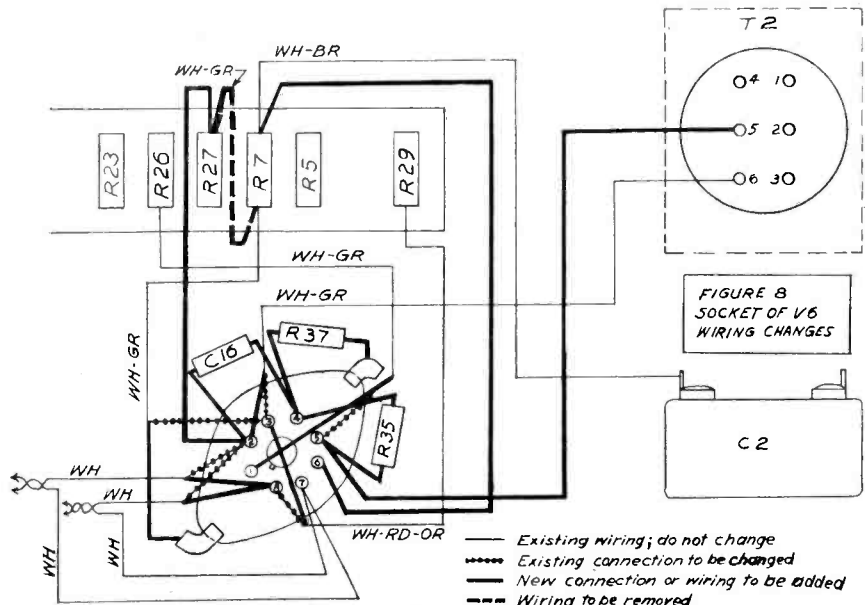
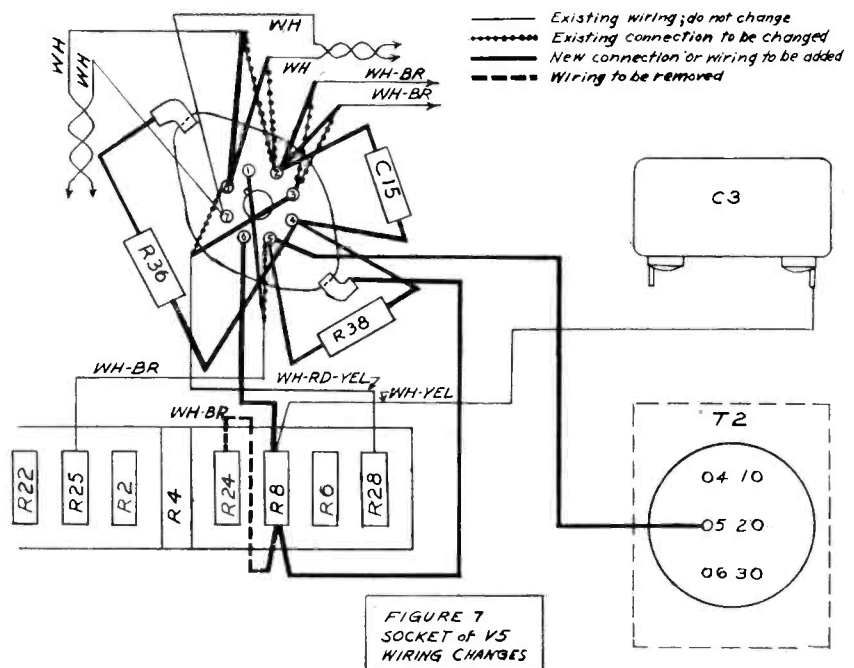
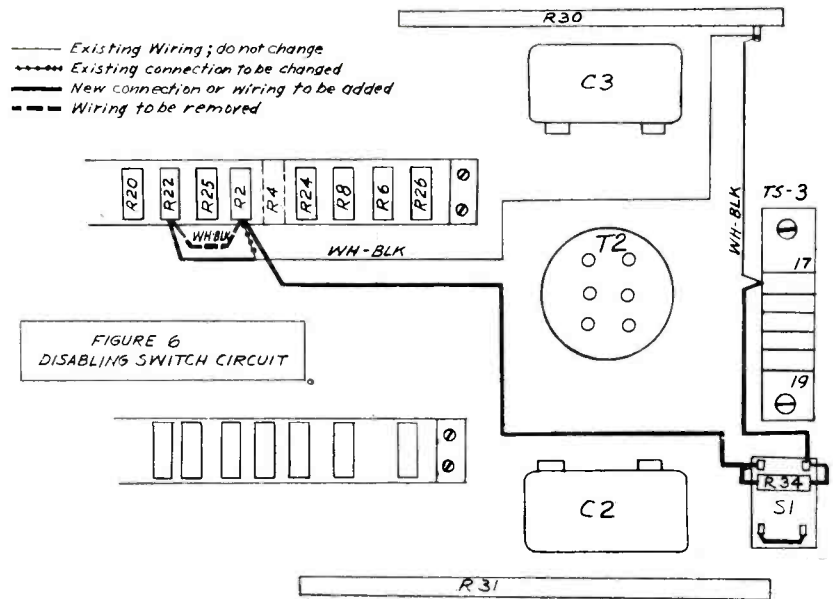

- (2) Condensers—(C2, C3), 0.5 mfd. \pm 20 per cent, 600 v., bathtub type; such as Cornell-Dubilier type D_{YR}-6050.
- (2) Resistors (R35, R38), 2.4 megohms \pm 10 per cent, 1/2 watt; such as I.R.C. type BTS or Allen-Bradley type HB.
- (2) Resistors (R36, R37), 1.2 megohms \pm 10 per cent, 1/2 watt; such as I.R.C. type BTS or Allen-Bradley type HB.

Those having early 126B models with a disabling switch (S1) circuit as shown in Figure 4B should first change this circuit to agree with that of Figure 4A. The only additional component required is R34 (refer to conversion of 126A to 126B).

Circuit of V5 (Note Figure 7)

In the 126A and 126B amplifiers, the ground lug on the socket of V5 is bent and soldered to the adjacent Pin No. 1. This connection should be removed (its removal is not indicated in Figure 7). The 6J5 is replaced by a 6SN7. This requires changing the filament leads and other socket connections. The first triode section of the 6SN7 (pins 1, 2, 3) is connected the same as the corresponding grid, plate, and cathode elements of the 6J5 triode were connected. Coupling to the other triode section is added, consisting of a 0.01 mfd. condenser (C15) and resistors R36 (grid to ground, 1.2 megohms) and R38 (grid to B+, 2.4 megohms). Resistor R8 is disconnected from the plate of V5 and reconnected to place it from the cathode of V5B to ground, and condenser C3 is replaced with a 0.5 mfd. condenser.

Circuit of V6 (Note Figure 8)

Changes in the circuit of V6 are made corresponding to the changes in the circuit of V5. The connection of the ground lug to pin 1 is removed. The 6J5 is replaced with a 6SN7. Coupling condenser C16 (corresponding to C15) and resistors R35 (corresponding to R38) and R37 (corresponding to R36) are added. R7 is disconnected from the plate of V6 and reconnected to place it from the cathode of V6B to ground. C2 is replaced with a 0.5 mfd. condenser.

For checking purposes, the following approximate voltages to ground should be measured with a 1000 ohms-per-volt d.c. meter, no signal input:

- Plate (pin 2) of V5A, and terminals 4 and 6 of output transformer T2: 257 volts (500 v. scale).
- Terminal 5 of T2: 262 volts (500 v. scale).
- Grid (pins 5) of V5B and of V6B: 34 volts (500 v. scale).

These are typical values only and may vary somewhat with different amplifiers.

When these changes are completed in the 126A and 126B amplifiers now in service, the users will have taken advantage of the latest design improvements made in this series of amplifiers, and they will be using up-to-the-minute level-governing equipment, the equivalent of the 1126C amplifier.

In operating the 1126 type amplifiers, it is recommended that 5 db of compression as indicated on the meter when the plate current switch is on position 1 not be exceeded on any types of program material which require transmission over a wide dynamic range. Because of the fast action of the control circuit and the relatively slow ballistic characteristic of the meter, the amount of level governing indicated on the meter when reading program material is not a true indication of the actual amount of limiting action being obtained. The correction of meter reading to give actual limiting requires a multiplying factor which varies from 1 for steady state sine wave to as much as 4 or 5 for program material having peaks of large magnitude spaced at relatively long intervals. In general, if the amount of compression indicated on the meter on normal material is doubled, a reasonably close approximation of the true amount of compression will be obtained. Therefore, when 5 db is indicated on the meter, the actual amount of level governing being used on average program material is approximately 10 db. The restriction on the amount of limiting to use results not from distortion introduced by the level governing action but from the limitation of dynamic range. As mentioned previously, limiting should be held to a minimum for the highest quality programs requiring wide dynamic range for faithful reproduction.

The increase in loudness that is obtained with limiting action exceeding 14 db is negligible. Increase in compression above this value will not add materially to station coverage because it brings a decrease in signal-to-noise ratio, and it may seriously degrade programs where the carrier is already sufficiently high to insure adequate coverage. Relatively high values of compression may be used with music if it is agreeable to restrict dynamic range, but the amount of compression that may be used with voice is definitely less than with music. High compression causes the voice to lose character, and male voices to sound unnaturally heavy.

When the precautions above are taken

into consideration, the user of a level governing amplifier can obtain the benefits of program peak limiting without introducing noticeable degradation of quality. With a high quality limiter such as the 1126C, with its low distortion, low noise level, wide frequency response, rapid acting control circuit, and adjustable recovery time, the maximum benefits of program operated level governing action may be obtained.

BOOK REVIEWS

Understanding Vectors and Phase, by John F. Rider and Seymour D. Uslan. Published by John F. Rider Publisher, Inc., New York. 150 pages, paper cover, approx. 5x7", price 99c.

This text has been written primarily for the radio student, amateur, serviceman, and technician to better familiarize him with this subject matter and to help him better understand the texts and technical literature. The chapter headings include: What is a Vector? The Coordinate System; Single Vector Representation; Multiple Vector Presentation; Resolution of Vectors; Addition, Subtraction, Multiplication and Division of Vectors; Radio Circuit Problems (including the discriminator circuit, and a simple phase modulator). The text is well illustrated.

* * *

High Frequency Measuring Techniques Using Transmission Lines—by Phillips, Sterns, and Gamara. Published by John F. Rider Publisher, New York. 8 1/2 x 11 inches, paper cover. 58 pages, at \$1.50.

The authors are members of the research staff of the Collins Radio Co.

At the present time, the most convenient tool for measurement in the frequency spectrum above 100 mc is a shielded transmission line with a continuous slot along its axial length. When properly equipped with a measuring scale along this length and an index to indicate the position of a probe which explores the field between the conductors, this equipment can be used to measure wavelength, impedance, velocity of propagation, electrical length, and attenuation in four-terminal networks. This treatise describes techniques for determining these quantities.

DO WE HAVE YOUR ZONE NUMBER?



**For recordings with a socko
To please engineer and jocko**

Advance
Recording Products Company
36-12 34th STREET • STILLWELL 4-7837 • LONG ISLAND CITY, N. Y.

Advance Recording Blanks

...no finer recording blanks anywhere!



Review of Current Technical Literature

By Lawrence W. Lockwood

Journal of Applied Physics, November 1947

The Theory of Disk-Loaded Wave Guides—E. Chu and W. Hansen

The properties of circular wave guides loaded with apertured disks are discussed both qualitatively and quantitatively. Formulas and curves are given for various quantities including the wave and group velocities, the attenuation, and the power flow.

Equations for the Inductances of Three Phase Coaxial Busses Comprised of Square Tubular Conductors—T. Higgins and H. Messinger

Equations are derived for calculating the associated inductances of the conductors of three-phase coaxial busses comprised of square tubular conductors.

Bell Laboratories Record, December 1947

A Microwave Relay System Between New York and Boston—A. Durkee

A history of the development of these repeaters and a description of their operation.

Communications, November 1947

FM and TV Transmission Line Installation Problems—J. Brown

Variety of special types of materials, components, accessories and methods used in installation of coaxial transmission lines from transmitter to antenna. Assortment includes special gas barriers, inner conductors and line supports, elbows, mounting fittings, clamp connectors, flanges, reducers, pressure controls, isolators, etc.

NABET Employment Service

Due to the day-to-day changes in status and availability of unemployed NABET members, it has not been deemed practical to publish such a list of names in each issue of the Journal. Instead, each available member should immediately notify the National Office, with copies to his Chapter Chairman, of availability together with brief resume of experience, etc., and notify them immediately of any change in status or availability. The Chapter Chairman for the area, and the National Office, each of whom are called upon to fill vacancies, will thus be kept up-to-date to the mutual advantage of all concerned.

Voltage Regulation in Broadcast Stations—L. Herterline Jr.

Voltage regulation plays major role in station operations, offering a means of curbing operating expenses over a long period, increasing transmitter efficiency and operation reliability.

Transmitting Antenna Inductive Coupling Methods—S. Wald

Theory and adjustment of swinging-link type of antenna coupling.

High-Powered R-F Linear Amplifiers—C. Corbett

A discussion of circuits designed to provide kilowatts of R-F power in A-M transmitters with low distortion, low residual noise and high fidelity. Analysis covers the high efficiency method of linear amplification featured in the Doherty circuit.

Proceedings of the I.R.E., December 1947

The Distortion of Frequency Modulated Waves by Transmission Networks—A. Gladwin

A general solution to the problem of calculating the distortion imposed on the instantaneous frequency of a frequency modulated wave in passing through a transmission network is obtained by a direct operation method. Approximate formulas for cases of large and small deviation ratios are derived and it is shown that a range of overlap exists in practical cases. The application of negative feedback to a frequency modulation receiver is considered.

Microwave Antenna Measurements—C. Cutler, A. King, and W. Kock

A description is given of the techniques involved in measuring the properties of microwave antennas. The requirements of the antenna testing site are taken up, and components of a complete measuring system are briefly described.

New Television Field-Pickup Equipment Employing the Image Orthicon—J. Roe

A brief review of the characteristics of the more widely used types of electronic television pickup tubes traces the trend toward greater sensitivity, culminating in the image orthicon. Former restrictions imposed by requirement for large amounts of illumination have been almost entirely removed. Each of the major units in the new field equipment (which may also be adapted for studio use) is described in some detail along with its function in the system. Discussion of some of the unusual circuits is included in the Appendix.

New CBS Program Transmission Standards—H. Chinn and P. Eisenberg

Over a period of years, broadcast listeners have complained that the musical portions of radio programs are sometimes unpleasantly loud—that is the music is too loud compared with speech. Two surveys conducted by CBS in 1940 and 1944 found this to be true of all broadcast stations, and established the validity of the complaints. This led to more definitive studies which were undertaken in 1945. They were (1) discover proper (pleasing-to-listener) relative levels at which music and speech should be transmitted, and (2) determine the range within which the peak levels of a program should fall in order to please the greatest number of persons.

Cloverleaf Antenna for FM Broadcasting—P. Smith

The radiation requirements and general design considerations for transmitting antennas suitable for fm broadcasting are briefly discussed and an explanation of the design and operation of the arrangement of radiating elements and asso-

ciated feed system employed in the cloverleaf antenna is given. Both calculated and measured data are included.

A Vacuum-Tube-Type Transducer for Use in the Reproduction of Lateral Phonograph Recordings—J. Gordon

A method is described wherein the lateral mechanical vibrations from a phonograph record are used to move a vacuum tube element which creates variations in the anode current comparable to the anode-current variations caused by a change in grid voltage in the regular triode-type vacuum tube. An experimental type movable-grid tube is shown, with the performance data. An applicable circuit is shown and other uses of the tube are mentioned.

Field Measurements On Magnetic Recording Heads—D. Clark and L. Merrill

A method is described for measuring relative values of the magnetizing force along the path traversed by the recording medium in passing through a magnetic recording or reproducing head. A method for calculating the frequency response of a reproducing head from field distribution data is presented and results of calculations are compared with measured frequency response.

Video Delay Lines—J. Blewett and J. Rubel

Continuous coaxial transmission lines are described in which velocity of propagation is about one one-thousandth the velocity of light. These lines include a solenoidal inner conductor and a Litz-braid outer conductor. Phase and amplitude distortions in such lines are discussed and design procedure are presented to yield lines of optimum performance under various conditions.

QST, December 1947

Sunspots and Very-High-Frequency Radio Transmission—K. Norton

The effects of the present (1947-8) high sunspot activity on the maximum radio frequencies usable for radio transmission via the ionosphere are discussed. A brief description is given of past and present sunspot activity and the predictions of future activity made by several research workers are compared with each other and with the actual sunspot activity observed during the early part of the present cycle.

Radio and Electronics (New Zealand) Dec., 1947

Tracking Error in Gramophone Pick-Ups

In this article the term tracking-error is explained and some indication is given of its importance and how it may be kept to a minimum.

A Practical Analysis of Ultra High Frequency Transmission Lines, Resonant Sections, Resonant Cavities and Wave Guides—J. Meagher and H. Markley

Definition of terms and diagrams of conditions existing in the above cases are presented along with simplified explanations of operation of these devices.

Tele-Tech, December 1947

Present Status of Printed Circuit Technics—Dr. A. Murray

Washington symposium, attended by over 700 engineers, reveals modern methods of producing unit components by many processes.

Measuring Instantaneous Frequency of an FM Oscillator—L. Hunt

A method for lining up an FM transmitter by matching oscilloscope traces and giving accuracy of 500 parts in a million.

Hazeltine Fremodyne FM Circuit

Combining superheterodyne and superregenerative principles, new tuner provides good selectivity and audio output, uses single dual triode.

Economograph For Determining FM Station Costs—R. Coile

Blending the economics of FM broadcasting and the mathematics of nomography to get costs of transmitter, antenna and tower.

Design of Television Transmitters For Low Level Modulation—J. Downie, L. Ewing, H. Gancher and J. Keister

Simple triodes in grounded grid circuits serve to raise level to desired power. Rapid tuning facilitated by Built-in sweep.

TV Pick PU From Moving Location

DuMont engineers successfully use remote from ship at sea to broadcast Connolly ceremonies in New York and Washington.

Microwaves and Propagation Top URSI-IRE Interest

Broad-band metallic lenses for relay networks and propagation research among major conference topics—Principal papers briefed.

Horizontal Scanning Generator and HV Supply—J. Bigelow

Analysis of Farnsworth "beam relaxor" which combines oscillator and high voltage generator in one tube giving light, compact unit.

Electronics, December 1947

Dynamic Noise Suppressor—H. Scott

Complete technical details of a system that provides essentially noise-free reproduction from phonograph records and transcriptions. Circuits are given for a 2 tube phonograph version and a 10 tube broadcast model.

Phase Monitor For Broadcast Arrays—B. O'Brien and F. Sherwood

The phase angle between any two directional antenna towers can be checked in thirty seconds to within a degree of the design value for the array, by a device that is mechanically simple to construct, easy to check or use.

Audio Noise Reduction Circuits—H. Olson

Simple circuit employing germanium diodes as nonlinear elements reduces phonograph record noise without substantially affecting desired signal.

Television Resolution Chart

Designed for the purpose of standardizing television resolution measurements, the chart illustrated has been made available to the industry by the RMA engineering department.

Audio Engineering, December 1947

Broadcasting Studio Sound Reinforcement—H. Chinn and R. Monroe

How special public address problems encountered in a broadcasting studio may be solved.

Noise Modulation In Recording—E. Cook

Causes of noise modulation in disc recording and how they may be overcome.

Review of the Present Status of Magnetic Recording Theory—W. Wetzel

In this series of three articles, Dr. Wetzel presents the first complete discussion of magnetic tape recording theory for engineers.

Two-Way Speaker System—C. McProud

The second of three articles describing the design and construction of an excellent two-way speaker system.

DU MONT TELEVISION CAMERA

THE release and delivery of Image-Orthicon Camera Chains incorporating the newly designed Du Mont image-orthicon camera is announced by Allen B. Du Mont Laboratories, Inc. The new camera developed and manufactured by Du Mont's Television Transmitter Department, displays features never before included in television cameras, according to Du Mont.

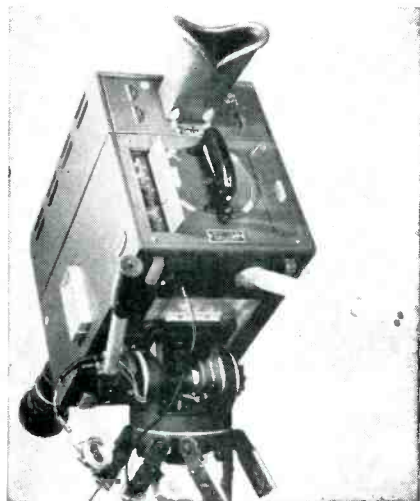

The outstanding impression created by the new Du Mont camera is its ease of operation, with all essential controls concentrated at the rear of the camera. Upon examination it becomes immediately obvious that the design is completely advanced with respect to the accessibility of components and circuits. Hinged and removable panels permit immediate adjustments and replacements in the field or in the studio with minimum loss of time.

Employing the new super-sensitive image-orthicon pickup tube, the Du Mont camera features a lens turret that takes up to four lenses of various focal lengths. The turret is operated by a rotatable handle at the rear of the camera, locking any one of the indicated lenses in position. Diaphragm setting is also controlled from the rear of the camera, while focusing is controlled by the concentric handle at the rear of the camera, which moves the image-orthicon tube back and forth.

To avoid parallax difficulties, the camera retains the Du Mont-originated electronic viewfinder. Mounted on top of the camera proper, this assembly slips down in place, at the same time establishing plug-in connections. The electronic

viewfinder chassis is included in the camera housing. The televised image as shown on the viewfinder screen is viewed through the shadow box at the rear of the camera. The camera can be operated with or without the electronic viewfinder, an optical viewfinder being provided when necessary.

The electrical flexibility of this camera matches its mechanical convenience. Voltage control is provided for a wide variation in pickup tubes. There are knob adjustments for all internal controls. The video pre-amplifier is essentially nonmicrophonic so that image pickup is virtually unaffected by vibration or jarring of the camera in operation. Tubes and sockets are arranged for immediate and convenient accessibility. Controls at the rear of the camera, made available by opening panel doors, regulate the heater or the blower for the operation of the image-orthicon tube at the proper temperature; centering of the electronic image; adjustment of the pre-amplifier gain and alignment coil current.

A pilot light flashes at the rear of the camera when it is "On the Air." If the cameraman is following the pickup through the electronic viewfinder, a second pilot light flashes inside the shadow box for the cue.

The camera takes a plug-in headset and microphone for use with the intercommunicating system of the studio or outside crew. The camera utilizes the Type 2P23 Image-orthicon and Du Mont newly



developed circuits—video pre-amplifier, blanking multivibrator, and horizontal and vertical deflection circuits.

The development and production of Du Mont's new camera completely balances the technical and operating advantages of the complete Image-Orthicon Camera Chain, which includes the Pickup Auxiliary, Low-Voltage Supplies, Synchronizing Pulse Generator, Camera Control and Monitor, Distribution Amplifier and Low-Voltage Supply, and the Mixer Amplifier and Monitor, and which is adapted to two, three or four camera operation. The Mixer Amplifier and Monitor is equally famous for its exclusive automatic Lap Dissolve and Fade Control.

If It Concerns

The Broadcast

Engineer



—he will read it in the
BROADCAST

ENGINEERS'

JOURNAL

Since 1934, Of, By, and For
The Broadcast Engineer

I.R.E. Convention

The Institute of Radio Engineers will hold its 1948 Annual Convention and Radio Engineering Show at the Hotel Commodore and Grand Central Palace on March 22-25. Theme of the convention and show is "Radio-Electronic Frontiers," and both the program and the exhibits are being planned to fulfill this theme. A diversified technical program consisting of 130 papers in 26 sessions has been arranged plus two special symposia with outstanding invited speakers on "Nucleonics" and "Advances Significant to Electronics." The annual banquet of the Institute will be held the evening of Wednesday, March 24, and the President's Luncheon on Tuesday noon, March 23. Both will feature national figures as principal speakers. A cocktail party is scheduled for Monday, March 22, at 6 P. M. On the opening morning on Monday, March 22, the Annual Meeting of the Institute will be held. At this meeting, an innovation at I.R.E. conventions, Dr. H. B. Richmond will address the membership on "An Engineer in the Electronics Industry—Prospect, Preparation, Pay."

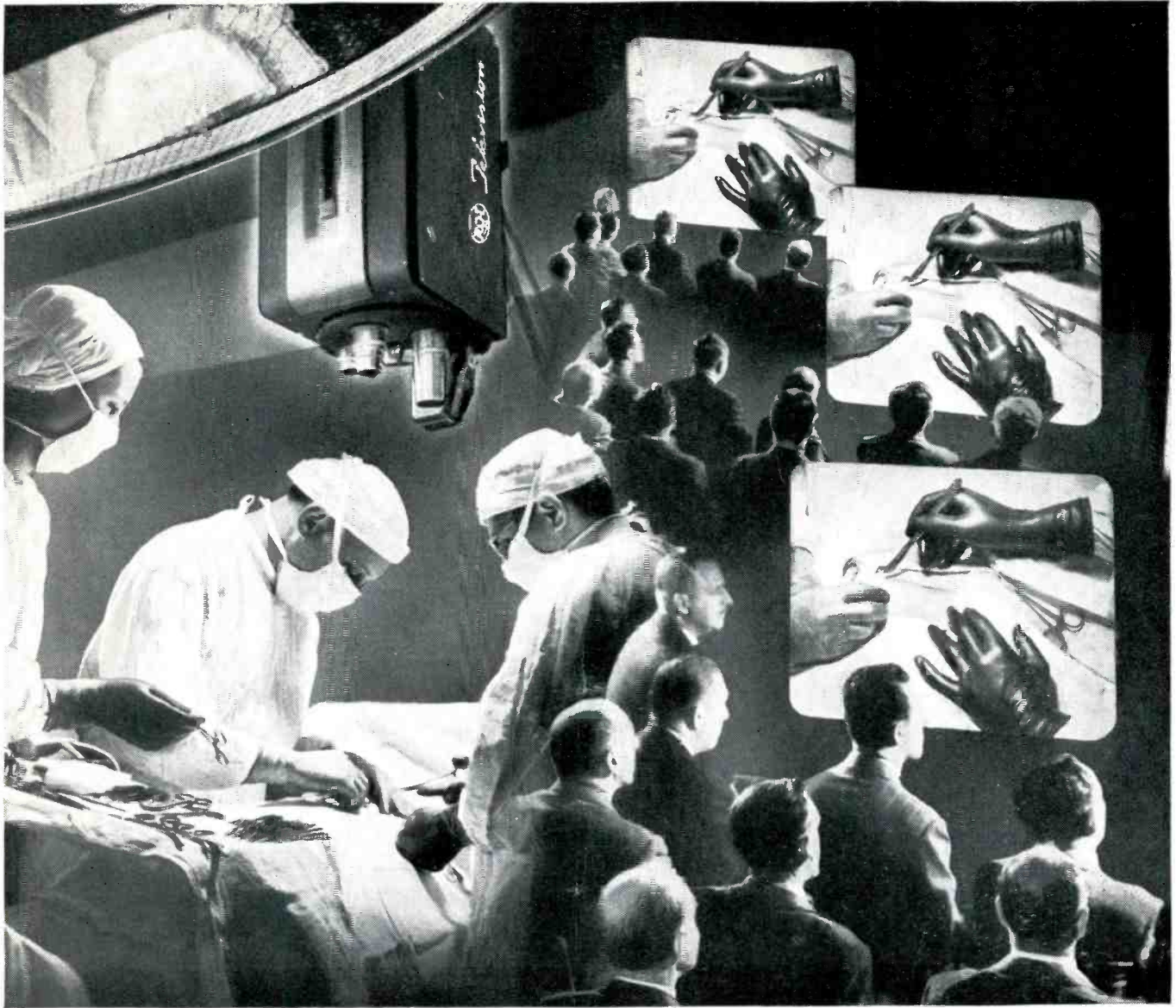

Successful telecasts of surgical operations show value of television to medical education.

"Step up beside the surgeon—and watch"

Not long ago, a radio beam flashed across the New York sky—and "carried" more than 7000 surgeons into an operating room . . .

Impossible? It was done by television, when RCA demonstrated—to a congress of surgeons—how effective this medium can be in teaching surgery.

In a New York hospital, above an operating table, a supersensitive RCA Image Orthicon television camera televised a series of operations. Lighting was normal. Images were transmitted on a narrow,

line-of-sight beam . . . As the pictures were seen the operating surgeons were heard explaining their techniques . . .

The beam was picked up at a midtown hotel—carried to RCA Victor television receivers. And on the video screens, visiting surgeons followed each delicate step of surgical procedure. Action was sharp and clear. Each surgeon was as "close-up" as if he were actually beside the operating table.

Said a prominent surgeon: "Television as a way of teaching surgery sur-

passes anything we have ever had . . . I never imagined it could be so effective until I actually saw it . . ."

Use of television in many fields—and surgical education is only one—grows naturally from advanced scientific thinking at RCA Laboratories. Progressive research is part of every instrument bearing the names RCA or RCA Victor.

When in Radio City, New York, be sure to see the radio and electronic wonders at RCA Exhibition Hall, 36 West 49th St. Free admission. *Radio Corporation of America, RCA Building, New York 20, N. Y.*



RADIO CORPORATION of AMERICA

★ You can buy all these **CANNON** plugs receptacles and accessory fittings

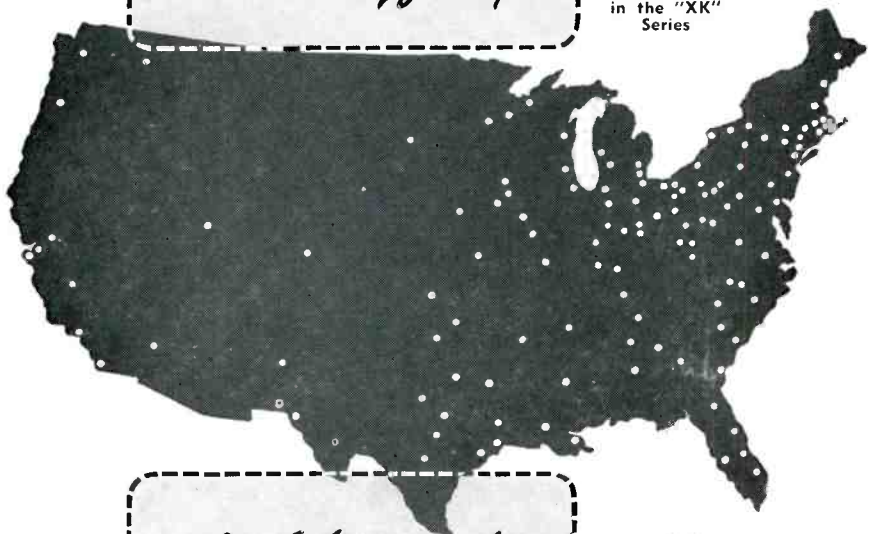

-in 6 type series from more than 200 distributors

To make it easier and quicker to obtain fittings in the above illustrated Cannon Electric Type Connector Series, more than 200* radio and electrical distributors can fill your requirements. Many of these distributors carry stock items on their shelves for immediate delivery. They are ready to serve you and discuss your requirements. Contact them first.

These type series are widely used on microphones, sound equipment, in radio and electronic devices. Their quality and performance are assured by Cannon Electric's thirty-three years of continuous operation under the same management. This service record is justified.

For a complete list of Representatives, Distributors and a Catalog covering these lines, write for Bulletins CED-4A and RJC-2, Address Dept. B-376.

XL-3-12 Plug in the "XL" Series



X-3-11 Plug in the "X" Series



XK-3-12 Plug in the "XK" Series



O3-11 Plug in the "O" Series



TQ-1-12 Plug in the "TQ" Coaxial Series



NEW P3-CG-115 Plug in the "P" Series



*Additional distributors are being added in many states.

WASHINGTON

By Warren Deem

Sincere thanks to Mr. Frank M. Russell and Mr. Carleton D. Smith for a really successful and entertaining reception for the NBC staff in Washington. Everyone who attended had a grand time. Instead of a dinner for employees, it was a reception for employees and their husbands or wives. It was held at a time when most of the employees had the opportunity to attend and just a couple of days before Christmas to make the Holiday Season complete.

Should any of you readers walk into the field shop of WNBW and see an article resembling one-half of a ship's hull resting on the tube locker, that is just what it is and the owner is 'Mac' McClelland. An expert on ships from the Smithsonian Institute says that the model most closely resembles the "Henry B. Hyde," year 1884 sailing vessel. If anyone has a second hand coat of paint this little model sure could use it. It will be a nice little, or should I say big, because the thing measures close to 6 feet in length, model though when "Mac" does find the time to paint it up and give it a new lease on life.

The crew in the WNBW film studios were having their fade-ins and fade-outs the first few days in operation. I asked Jim Weaver if he had any humorous incidents to relate and his reply was short and to the point, 'nothing funny here, its sad.' I caught him right after he had previewed one quarter reel of film before discovering that the "ike" was in front of the wrong port; good reason for his unhappy attitude temporarily.

Maybe one of the factors influencing the "New look" in ladies fashions in D. C. is the age of the movies that George Dorsey has been able to get. Things are "looking back" aren't they George?

Wild Bill Simmons and his Westerners, Frank Gaskins and Bill Wells are pleasing the younger generation with the "bang-em-up" westerns that they are showing. "Joe" Colledge's two boys sure love them and are never far from a receiver from start to finish when they come on.

When Sam Newman was asked how things were going at the WNBW transmitter since master control has been moved, he remarked that things had slowed down considerable. Bob Barnes happened to overhear and in short order

CANNON ELECTRIC



Development Company 3209 HUMBOLDT ST., LOS ANGELES 31, CALIF.

IN CANADA & BRITISH EMPIRE:
CANNON ELECTRIC COMPANY, LTD.
TORONTO 13, ONTARIO
REPRESENTATIVES IN PRINCIPAL CITIES

WORLD EXPORT (excepting British Empire):
FRAZAR & HANSEN, 301 CLAY STREET
SAN FRANCISCO 11, CALIFORNIA

SINCE 1915

presented Sam with a list of maintenance details as long as his arm.

Apologies to Monroe Morgan for not listing him and his call letters in the 1947 Yearbook. Monroe works at WRC studios and his call is W3GHC. We want to correct an error in listing Vic Leisner's call letters, the correct call is W3LGV.

Who is the engineer who after the signoff can be found looking for loose change in and around the cushions of the divans in the WNBW Transmitter viewing room. Hmmm!

A newcomer to WNBW field crew is Mr. Wm. M. Galvin. Mr. Galvin goes by the nickname of "Mike." We already have a "Mike" Vossler whose real name is Wm. M. also. We had to dub Vossler "Mike" instead of Bill because we had two "Bills" when Vossler came to work. The other Bill was Wm. Simmons. Now that Simmons is at Mastercontrol we will leave Vossler at "Mike" and will have to call Mr. Galvin "Gal," confusing isn't it? Gal is a Group 11 man and is a graduate of Bellevue Naval Radio School. He graduated second from the top in his class. He served on board the USS Okanogan during the latter part of the war. He was out of the Navy just a month when he came to work for NBC. Gal is a native Washingtonian, one of the few of an almost extinct race at NBC in Washington.

The story from WNBW field crew for this month is the engineer's view of three fast moving days that included televising a commercial show after the Joe Louis title bout Friday night, the All High-All Prep football playoff at Griffith Stadium Saturday, Dec. 6, the George Washington-Wake Forest basketball game that night and the Colt-Brown game in Baltimore the next day. As far as the audience was concerned things went along smoothly without a hair out of place, but by Sunday night Joe Colledge was all but pulling his hair out by the roots.

We went on the air on time and put on a good technical program. After the football game we had to hurry in order to clear the stadium for the night football game. We just cleared the field with equipment and truck in time. Our next job, three hours later, was at Lane High School. This was to be the first basketball game for over half the field crew. "Mike" McClelland and Warren Deem started on the cameras and as the platform was only 10 feet from the boundary line of the court very fast panning had to be done. Dodd Boyd, waiting his turn to manipulate one of the cameras almost laughed himself silly watching "Mac" and Warren swing their cameras around

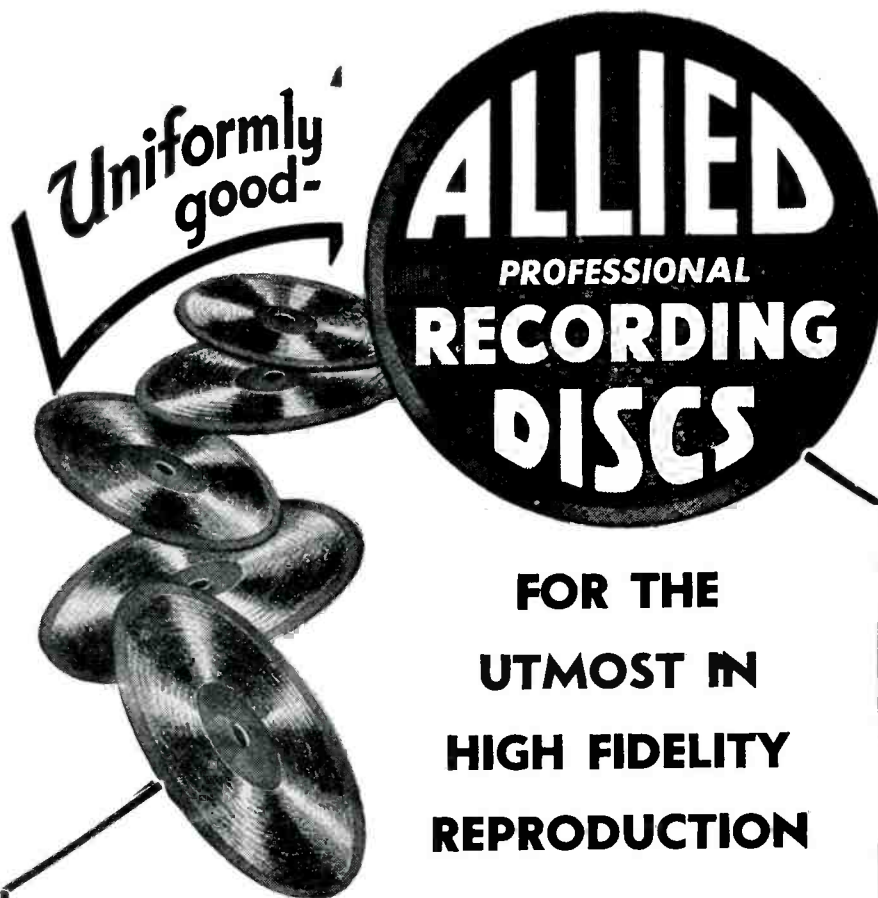

Uniformly good-

ALLIED
PROFESSIONAL
RECORDING
DISCS

FOR THE
UTMOST IN
HIGH FIDELITY
REPRODUCTION

Allied Professional Recording Discs are manufactured to exacting standards by one of the pioneers in the field of instantaneous recording equipment. The accumulated knowledge of years of experience have been engineered into Allied Discs. TRY them.

Also ALLIED RECORDING EQUIPMENT

The Allied Recording Machine (illustrated) combines the Allied Transcription Turntable and Allied Overhead Cutting Assembly, which are also sold separately. Like Allied Discs, this equipment is of highest precision quality, good for long, trouble-free service.



ALLIED
RECORDING PRODUCTS CO.

21-09 43rd AVENUE

LONG ISLAND CITY 1, NEW YORK

WRITE FOR NEW DESCRIPTIVE BULLETIN

so fast. The show went off with very smooth results. After the truck was loaded the gang looked forward to five hours sleep. Several of the crew slept on the case racks at the field shop. Next day "groggy" and early the crew was on its way to Baltimore to take the final football game of the Colt's Baltimore schedule. The season started in a driving rainstorm and for a couple of hours it looked as if it may end in warm sunshine, but no such luck. At halftime a steady cold drizzle started that lasted continually through the final gun. The Stadium lights had to be turned on the last few minutes of the game. That made the pictures technically good, but the actor for the local commercial was on the opposite side of the game in respect to the cameras and the assistant director, Bob Doyle had to hold a flashlight on the face of the commercial actor to aid in taking of the closing commercial. On the final placard raindrops were seen running down. The home viewers must have had a very warm and satisfied feeling relaxing in their fireside armchairs while at the stadium the crew prepared to knock down the equipment in the unwelcome Balti-

more drizzle. It's a rough life, but every man on the crew loves it, the crazy characters.

Carson A. Andrick of Station WOL is having very good luck with his "Bee + " supply. I'm referring to the variety that buzzes from flower to flower gathering pollen. Carson hopes to be able to retire to his bee farm in a couple of years.

Warren S. Bell, formerly of Station WOL in Washington, is now in Front Royal, Va., in charge of station WFTR.

Three new members were recently added to WOL's Technical Staff. Lew Parrish and William Book transferred from the WLEE group in Richmond, Va., and Charles Meng joined our staff after transferring from WPIX, Alexandria, Va.

Ted Belote, Senior Supervisor, recently returned to his desk after a serious illness of many weeks. His physician has ordered him to refrain from any strenuous work so Ted is restricted to only a few hours at his desk each day.

Field Supervisor, Bill Cornell, Station WOL is hard at work in his spare time trying to clean up his operation "MOVE"



is the only union of broadcast engineers whose sole concern is the welfare of the broadcast engineer.

after deciding you just can't raise an increasing family in a bungalow.

WOL's Musical Clock Engineer, Jack Neff recently traded his Ford in on a new Roadmaster Buick. When he tried to make a deal with Porter Ben Johnson to "shine 'er up," Johnson insisted on a higher price than formerly. His comment was "the darn thing is just too long."

William "Don" Herman was so impressed with the need of Washington's 10 most needy families, with whom he helped make wire recorded interviews, that he started a personal campaign to make sure all the families had a Merry Xmas.

Rumors are flying that Ray Kaplan's wife did not "accordianize" the front fender of his new Pontiac while taking a driving lesson. A little birdie tells us that Ray may have hit a post while trying to squeeze into his parking space.

Hershel Stark, Station WOL, was trying out his new Quick Heat Iron that he won in a John Rider Contest and found it so quick-heating that he burned his fingers before he could get his hand away from the "business end."

Does anyone know how to get two days' work done in one? "Zolt" Bogar finds that he doesn't have time enough to finish many of his projects since Jr. arrived on the scene.

Bellum Miller, Transmitter Supervisor, is working like mad to get WOL-FM operating, but every time he gets buried in the new Westinghouse Job, Kline Mengle makes another contact with his mobile rig. Bellum says why worry about 20,000 watts when you can get such coverage with 15.

Bill Book, one of the newest members of WOL's Studio Engineering Staff decided it was too costly to commute to Richmond to see his one and only so he married her and brought her to Washington. Congratulations Bill to both of you from all of us.

NEW...IMPROVED

PRECISION ATTENUATORS

by TECH LABS

TYPE
850-A 850-B

The units illustrated represent a complete redesign of our older precision attenuators for laboratory standards. Flat for all frequencies in the audio range. Reasonably flat to 200 k.c. up to 70 db.

Bulletin sent on request.

TECH
LABORATORIES, INC.

Manufacturers of Precision Electrical Resistance Instruments
337 CENTRAL AVE. • JERSEY CITY 7, N. J.



CHICAGO

By Minor J. Wilson

CHICAGO lived up to its reputation of being the windy city when on New Years Day one of the worst wind-rain-ice-sleet-snow storms hit the Chicago vicinity, lashing, twisting and wrecking both commercial and amateur installations in vast numbers. Some broadcasting stations lost as many as four towers, others merely lost power and a little time on the air. WAIT suffered the complete destruction of their antenna, the second time in weeks for ED JACKER and the boys to lose an antenna. ED and McClanthan went without sleep from New Year's Day until Saturday, Jan. 3rd setting poles and installing an inverted L. WMAQ and WENR-WLS lost power and were forced to operate on reduced output with emergency diesel equipment. WENR-WLS also lost their feeder line and after an emergency call to RCA a 3000 foot reel of wire was shipped by way of pullman on the Pennsylvania Railroad. The wire traveled to Chicago on a reservation made in the name of ED HORSTMAN. (What a buildup and what a spot for a dirty dig, but I will let it go.)

JIM PLATZ claims to be the only member of the local gang who had a rotatable beam which suffered no damage. The worst damage was to IKE EICHORST's super antenna farm. IKE lost his 80' telephone pole in spite of standing out in the worst of the storm pulling on an antenna which was strung from the top of the pole, trying to hold it up against the wind. He had the heartbreaking experience of seeing it break 60' up and come toppling down a mass of wire and insulators. IKE is our most active ham and it will take more than a small breeze, Chicago style, to keep him off the air.

JOE RIFE also had his moments of anguish in connection with the big blow. A brand new \$24 extension ladder carefully laid across two benches to keep clean and dry was smashed by a falling tree. All efforts to persuade him he was better off, now that he actually had two instead of one, failed.

And the bamboo pole supported 'J' atop the roof of the Civic Opera for WEJH 100 watt relay broadcast transmitter was also downed. The steeplejack, ROBERT REYNOLDS who is re-installing it, is a former WMAQ transmitter man of long years ago. He quit WMAQ to make more money steeplejacking, but is now sorry he ever thought of leaving just 15 years ago.

The recording lull at NBC, RCA, and UNIVERSAL is quite a contrast to the mad month of December. Now there is talk of UNIVERSAL moving to Mexico.

The Lou Heiden son and heir was born on Xmas Eve,

(To page 20)

CAPPS*

SAPPHIRE is, and has always been, the only material for making cutting styli for high class recordings.

CAPPS* Patented Sapphire Styli (2187512) are the original and accepted standard for high class professional acetate recordings.

Imitated but not equalled

FRANK L. CAPPS & CO., Inc.

244 W. 49th STREET NEW YORK CITY

Telephone Circle 6-5285

*Reg. U. S. Pat. Off.

Why engineers like to shop at NEWARK...

COMPLETE STOCKS
of Radio and Electronic Equipment, components, accessories. NEWARK maintains one of the largest inventories of standard brands in America. Whatever you may need... WE'VE GOT IT IN STOCK!





DEPENDABLE SERVICE
Engineers, who "live by the clock" have learned to depend on NEWARK'S speedy efficient service... our high-g geared organization of trained personnel know how important YOUR order is to YOU... mail and phone order shipped same day!

THREE GREAT STORES to serve you... centrally located in New York and Chicago... always first with the latest in Radio and Electronics... now featuring:

- NEWEST TELEVISION SETS, Philco, RCA, other fine quality models, on demonstration.
- RECORD CHANGERS, RECORDING EQUIPMENT. Deluxe models, to delight an engineer's heart!
- HAM GEAR for Radio Amateurs. All makes, all models, everything you need, from tiny tip jacks to complete transmitters!

VISIT
any of our Three Great Stores... write for Latest Bulletin of Values... order by mail or phone — you'll agree "IT'S A PLEASURE to do business with... NEWARK!"

NEW YORK
Offices & Warehouse
242 W. 55th St., N.Y. 19

NEWARK
ELECTRIC COMPANY, INC.
323 W. Madison St.
Chicago 6, Ill.

New York City Stores: 115-17 W. 45th St. & 212 Fulton St.

Labor History — IV

From the Labor Information Bulletin

During the bitter union-employer struggle of 1873-83, the union movement became involved in an internal contest over its own organizational structure. The issue was whether Nation-wide organizations should be based on direct affiliation of local unions and city councils, regardless of trade lines, or on existing trade-unions.

Direct local affiliation, which had been tried unsuccessfully several times, was championed by the Knights of Labor, founded by Uriah S. Stevens in 1869 as a local union of Philadelphia garment workers.

For some years, the Knights of Labor functioned as a secret society, because, as one labor leader said, "a great deal of bitterness was evinced against trade-union organizations, and men were blacklisted."

Membership in the Knights of Labor was estimated at 10,000 in 1879. By 1886, a Nation-wide membership of 700,000 was claimed. The first general assembly was called in 1878 and Stevens was elected Grand Master. However, he resigned a short time later and was succeeded by Terrence V. Powderly.

The Knights stressed educational and political methods and had as a broad aim a cooperative society. Their program called for the 8-hour day, equal pay for women, abolition of convict and child labor, public ownership of utilities, and the establishment of cooperatives.

Though a successful, but severe, strike against the powerful Gould railway system brought the Knights particular prestige, leaders who favored the processes of collective bargaining clashed with those committed to political means.

Meanwhile a new organization devoted to higher wages and better working conditions had stepped into the picture. Led by Samuel Gompers and Adolph Strasser of the Cigar Makers' Union, six prominent craft unions—cigar makers, printers, iron and steel workers, molders, carpenters, and glass makers—and a variety of other labor groups met in Pittsburgh in 1881 and established the Federation of Organized Trades and Labor Unions. They had 45,000 members at the start.

In 1886 several large craft unions broke away from the Knights, which refused to respect their jurisdiction, and, meeting at Columbus, Ohio, founded the American Federation of Labor. The F. O. T. L. U., which was holding a convention in Columbus, amalgamated with the new group. Gompers was elected the first president of the American Federation of Labor, a position which he held continuously with the exception of 1 year, 1894-95, until his death in 1924.

From its original membership of about 138,000, the AFL

doubled its strength in 12 years. Until 1890, rivalry with the Knights continued and frequent efforts to effect working agreements failed. The Knights reported only 100,000 members in 1890 and thereafter ceased to be an influential factor in the labor movement.

In the three decades starting in 1890, the American Federation of Labor grew and consolidated its position as the principal federation of American unions. From 1900 to 1904, membership rose rapidly from 500,000 to a million and a half. By the outbreak of World War I, two million American workers were in the AFL. During the war years, membership again rose rapidly, reaching more than 4 million in 1920.

During this entire period, between 70 and 80 percent of all union workers were in the AFL. The most important un-affiliated groups were the four "railroad brotherhoods" which usually maintained friendly relations with the AFL affiliates.

Prior to World War I the principal union gains occurred in coal mining, railroad, and building trade-unions.

The labor movement's development as an influential national economic group did not take place without opposition. In the 1890's the new large corporations which had appeared on the economic scene vigorously fought efforts at unionization of their employees.

("Labor U. S. A.—Renewed Industrial Conflict" next month.)

P. T. Barnum Is Alleged to Have
Made This Wise Observation:

If You Don't Advertise Your Business, the Sheriff Will

We Are Confident in the Future, Are You?
FOR ADVERTISING RATES AND DATA

Write: THE BROADCAST ENGINEERS' JOURNAL
116-03 91st Avenue Richmond Hill 18, N. Y.

CHICAGO—from page 19

mother and son are doing fine. That makes four babies born to CHICAGO NBC engineers in less than four months. Maybe we are not getting as old as we thought we were.

AL OTTO is taking an unusual interest in art the past few weeks. When AL takes an interest in any new subject he goes in for it intensively. More than likely we will hear soon that he has enrolled for classes at the ART INSTITUTE.

Major revamping, and rewiring of the WMAQ transmitter equipment is in full progress between sign off and sign on. The changes amount to many thousands of dollars and involve the time of two NY NABET men who are doing the actual work.

BILL CUMMINGS and crew of ABC engineers have been working long hours in the CIVIC OPERA building installing the ABC CHICAGO FM transmitter which went into operation Jan. 1. The installation is an RCA transmitter powered from a rotary converter as only DC was available. The transmitter is located in the former Samuel Insull penthouse.

Two cartons of fancy WMAQ matches were distributed to each employee just before Xmas. The truth is, the fire marshall made an inspection and declared the matches presented a fire hazard and must be disposed of THAT day. The fire hazard is now equally distributed amongst all employees. That is one Xmas bonus we participated in.

SUBSCRIPTION BLANK

THE BROADCAST ENGINEERS' JOURNAL
116-03 91st Avenue, Richmond Hill 18, N. Y.

Gentlemen: Please enter my subscription to The Broadcast Engineers' Journal to start with the next issue.

Name..... (Station.....)

Address

City, P. O. Zone, State.....

Check attached for \$2.50, 1 year; \$4.00, 2 years.

WHAT MAKES A GOOD RECORDING BLANK GOOD*



№2



RECORDING LACQUER

- *The 'Broadcaster'*

10" 12" 16"

- *The 'Playback'*

6½" 8" 10" 12" 16"

- *The 'Audition'*

6½" 8" 10" 12" 16"

- *The 'Maestro'*

12" 13¼" 17¼"

- Everyone is familiar with lacquer in some form or other. Only a handful of chemists, however, are tops in the field of *recording* lacquer.
- Recording lacquer consists basically of cellulose nitrate, a plasticizer to control the consistency, and a dye to blacken it. Minor constituents and specialized procedures complete the compounding. The development of recording lacquer has been going on for over twenty years. Fortunes have been spent improving it.
- A good formula must combine properties that, offhand, seem irreconcilable. It must be soft to cut, hard to resist wear; heavy for quietness, light for smooth application; lubricated for low friction, oil-free for processing. To a high degree the Soundcraft formula reconciles these requirements. *But that is only half the battle.*
- Developing the formula was indeed no small task, but *controlling* it in commercial quantities is a delicate undertaking, too involved to describe here. Suffice it to say, however, that, confident of its formula, Soundcraft puts the emphasis on control so close that the recording engineer can *predict* performance.
- When a better formula is available, Soundcraft expects to have it. In the meantime Soundcraft doesn't experiment on *you*.

*Watch this space for succeeding ads in this informative series on how Soundcraft discs are made.



REEVES SOUNDCRAFT CORPORATION
10 EAST 52nd STREET • NEW YORK 22, N. Y.

**Direct
Cueing
Control**

without auxiliary switches

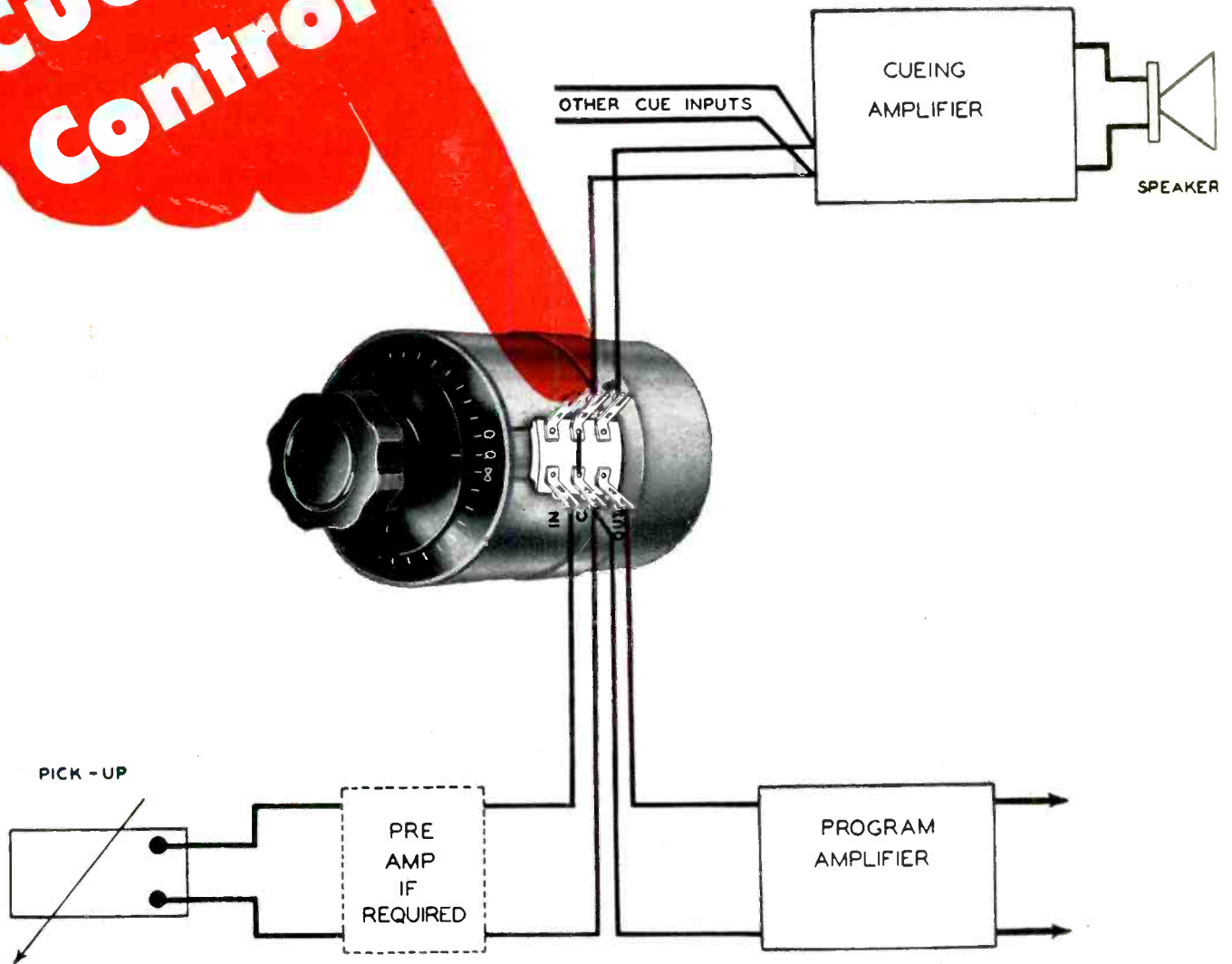

DAVEN ATTENUATORS with Built-in cueing controls are now available . . .

DAVEN attenuators may now be obtained with a cueing control. Auxiliary switching mechanisms are no longer required to cue recordings, transcriptions and remote or network programs.

The control itself will serve to transfer the program material to a separate cueing amplifier. Provision is made at the extreme attenuation position for connecting the incoming signal to a cue circuit before "fading in" the signal. As a result, a program can be smoothly "brought in" at the right time without the operation of any additional switches. A lug on the terminal board is provided for connection to the cueing system.

The cueing feature may be supplied on any type of Daven attenuators. However, it is primarily recommended on those controls used for mixing, which are provided with a taper to infinity. For further details write to our Sales Department.

APPLICATIONS

Broadcast Stations
Recording Studios for Playback
Wired Music Services
Sound Film Industry
Dubbing & Re-recording for Sound Effects

THE **DAVEN** CO.
191 CENTRAL AVENUE
NEWARK 4, NEW JERSEY

www.americanradiohistory.com